

Bridge Systems

**Infantry
Assault
Bridge**

IAB





IAB • Infantry Assault Bridge

The Infantry Assault Bridge IAB is a lightweight foot bridge for infantry, airborne and special operation forces. The bridge modules are made of high-tensile aluminum extrusions. One complete bridge set is qualified to produce a clear span bridge up to 30 m. With the adaptation of floats also wet gaps of various lengths can be crossed.



IAB Unique Performance

- Construction of a 30 m bridge in approximately 6 minutes
- Easy handling and operation due to robust and simple design
- Transport of complete bridge set by light truck; single modules can be hand carried
- Air-transportable by helicopter or fixed wing aircraft

IAB Bridge Set

Considered as one transport unit an IAB bridge set consists of the following components:

- 7 bridge modules and 1 float
- 1 assembly / disassembly support roller
- 1 transport & protection pallet
- 2 stretcher adapters
- 1 bridge assembly and anchoring kit

IAB Operations

IAB Bridge Set in Assembly Area



Transport of IAB Modules



Launching Preparations



Launching the First Modules



Water Crossing with Attached Float



Pushing to the Far Bank



Bridge Extension with Float Support



Use of Stretcher Adapter



IAB Technical Data

Bridge

Free span (maximum)	30.00 m	98 ft 5"
Maximum length (depending on the water-location)		x times 22 m
Module length	4.43 m	14 ft 6"
Width of foot bridge	0.35 m	1 ft 2"
Height of railing	0.71 m	2 ft 4"
Clear railing width	0.66 m	2 ft 2"
Module weight	55.50 kg	122 lbs
Bridge set (30 m) weight (incl. float and anchor devices)	460.00 kg	1,014 lbs

Transport & Protection Pallet

Length	4.78 m	15 ft 8"
Width	2.22 m	7 ft 3"
Height	2.37 m	7 ft 9"
Total weight (without bridge set)	480.00 kg	1,058 lbs
Total weight (with 30 m bridge set – incl. all devices)	940.00 kg	2,072 lbs

Performance

Construction of a 30 m bridge		approx. 6 minutes
Crossing rate of marching (30 m bridge)		approx. 8 men / min
Maximum weight per soldier (incl. all equipment)	135.00 kg	298 lbs

Transport

Land	any light or medium truck (transportable with or without transport & protection pallet)	
Air	- On transport & protection pallet	C-130, C-160, C-17, C-5, C-141, A 400M
	- Without transport & protection pallet	transport plane and helicopter (payload > 500 kg)
	- Deployed as underslung load	helicopter (payload > 500 kg)

Bridge Module

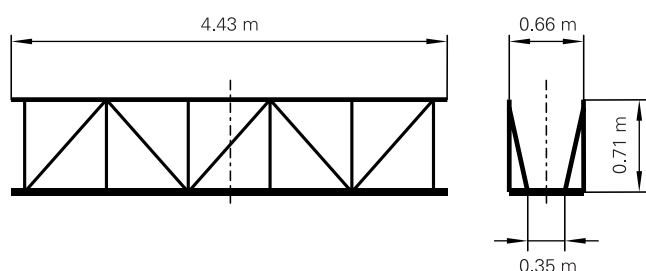

Transport & Protection Pallet

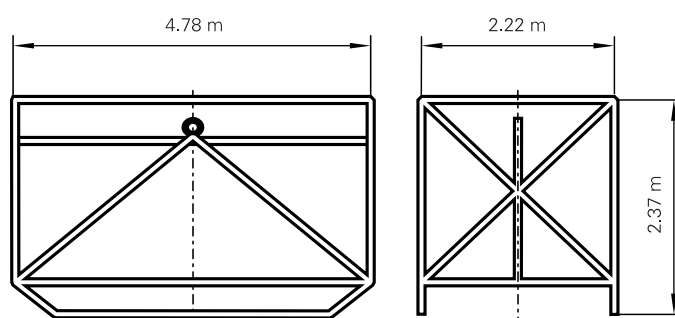

IAB Bridge Set (30 m) on Transport & Protection Pallet

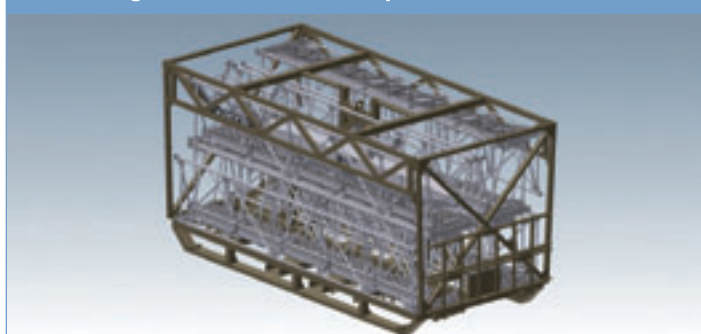



IAB Configurations

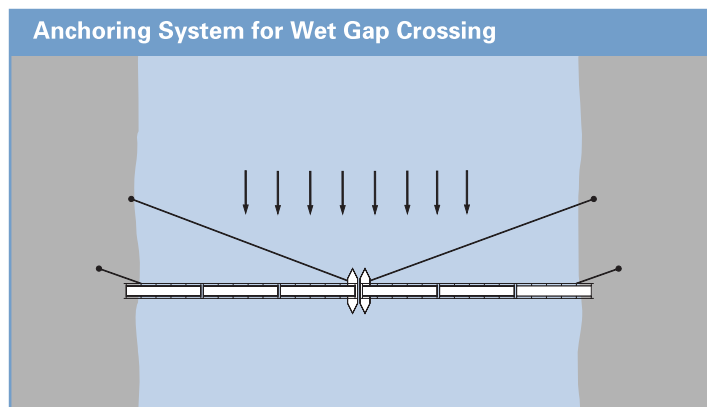
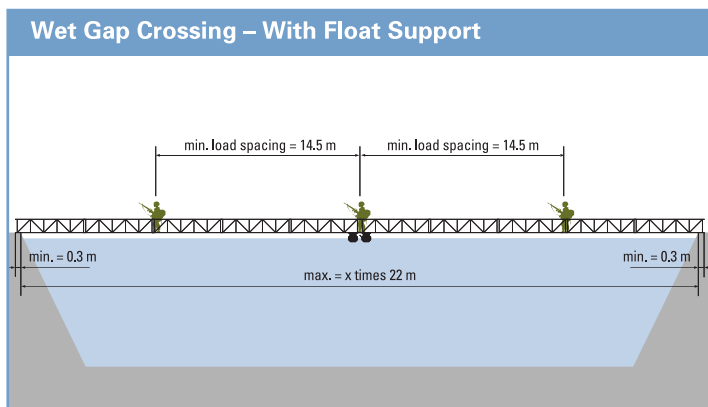
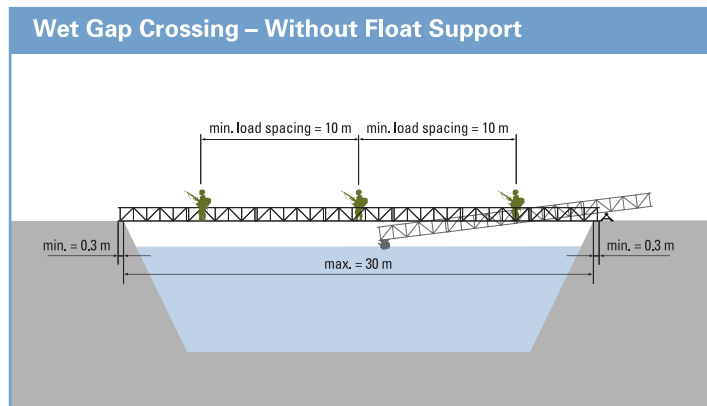
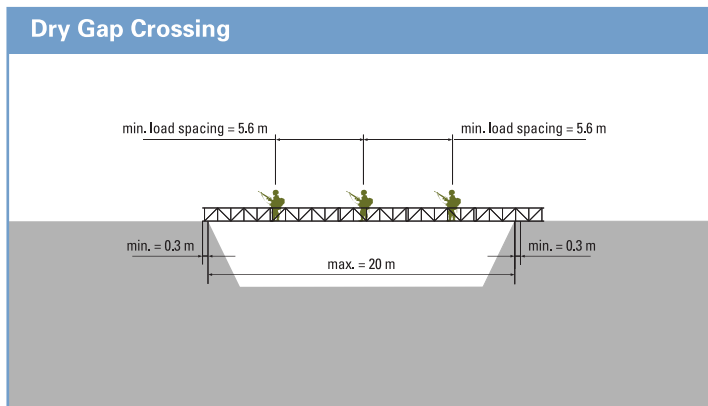

Additional Operational Configurations

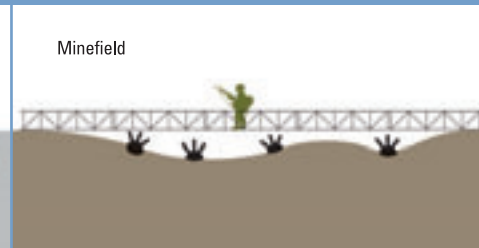
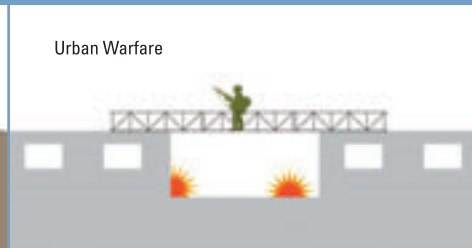

GENERAL DYNAMICS

European Land Systems

Defense Solutions for the Future

General Dynamics European Land Systems–Germany GmbH
Barbarossastrasse 30 · 67655 Kaiserslautern · Germany
Phone +49 (0)631 3616 0
Fax +49 (0)631 3616 300
info.bridges@gdels.com
www.gdels.com

